

Global Product Catalog
CT, Interventional Radiology, Ultrasound
and Emergency Department

Dear current and potential healthcare partners,

Thank you for considering UreSil to fulfill your product needs. UreSil, LLC, which is located in Skokie Illinois, is an owner operated medical device manufacturer that produces all of its own products in North America. UreSil is currently focused in the Radiology and Vascular Surgery Arenas and is dedicated to continuously developing and marketing innovative devices that provide clear benefits for the patient, clinician and supply chain. Every product that is brought to market must satisfy these requirements so that the objective of impacting healthcare in a significant and positive way can be achieved above all else. UreSil brings these products to market by utilizing an expansive global sales force that is accessible, knowledgeable and dedicated to the shared mission of improving clinical outcomes throughout the world. Over the course of its extensive history, UreSil has experienced significant growth and has arrived as a leader in product development, concept acceleration and manufacturing. We partner with numerous physicians, GPOs and IDNs and possess a relentless obsession with developing relevant medical devices that can save or improve lives while drastically improving the continuum of care that you work so hard to achieve.

It is our sincere hope that our products assist you in your mission to provide the highest level of healthcare for your community. Should you have ideas for further innovation or concepts that require further development to become reality, please reach out to us and we will be thrilled to engage with you to attempt to make the world a better place in earnest. In the meantime, please feel free to browse our catalog to familiarize yourself with our current product offering.

Sincerely,



Brett A. Hazuka
Global Vice President
Sales and Marketing
UreSil, LLC
Sales@UreSil.com
800.538.7374



Origin®

Drainage Catheter

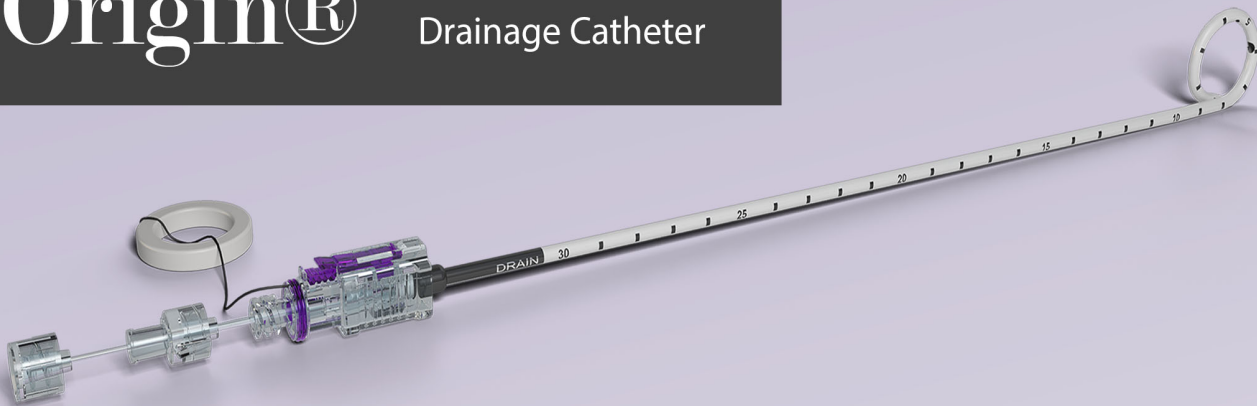

- The Origin Catheter is the culmination of years of research and development.
- Origin now features a clear hub for better visualization, an improved catheter material for insertion ease, an improved tip taper on larger sizes, the largest holes currently available on the market and depth marks that can confirm catheter position. Origin will be comprised of all general purpose “H” suffix codes, and provides an idea of the innovation we are providing in the drainage market.
- Every Origin General Purpose Catheter (GP) includes the following; Catheter, Metal Cannula, Flexible Cannula, Trocar and Hydrophilic Coating. The 6F catheter also includes an obturator.
- Origin Catheters are available in 6F through 16F diameters.

Product Code	Size/Length	Units/Box	Stiffness
GPL2-0625H	6 F / 18 cm	5	Origin
GPL2-0830H	8 F / 21 cm	5	Origin
GPL2-1030H	10 F / 21 cm	5	Origin
GPL2-1230H	12 F / 20 cm	5	Origin
GPL2-1430H	14 F / 21 cm	5	Origin
GPL2-1630H	16 F / 21 cm	5	Origin

Product Code	Size/Length	Units/Box	Stiffness
GPL2-0830HB	8 F / 21 cm	5	Regular
GPL2-1030HB	10 F / 21 cm	5	Regular
GPL2-1230HB	12 F / 20 cm	5	Regular
GPL2-1430HB	14 F / 21 cm	5	Regular
GPL2-1630HB	16 F / 21 cm	5	Regular



Mini-Pigtail® Drainage Catheter with locking pigtail

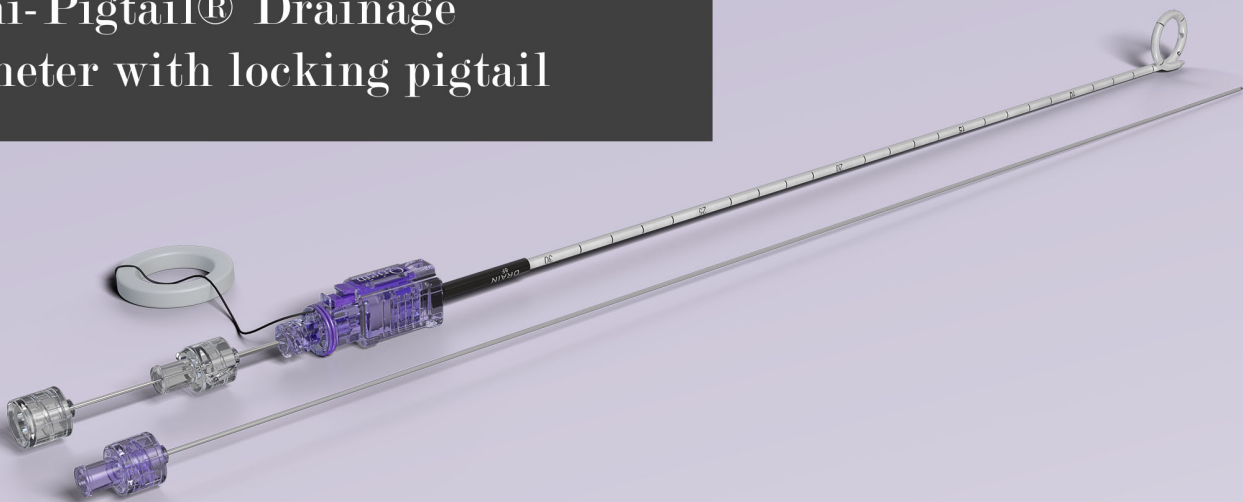

- UreSil's "MiniPig" (MP) Catheter is very similar to the General Purpose Catheter but is designed with a reduced size pigtail that presents a smaller footprint within an abscess, and is generally used for abscesses near critical structures.
- Every MiniPig General Purpose Catheter includes the following; Catheter, Metal Cannula, Flexible Cannula, Trocar and Hydrophilic Coating.
The 6F catheter also includes an obturator.
- MiniPig Catheters are available in 8F through 10F diameters in both durometers.
6F available in the Origin® material.

Product Code	Size/Length	Units/Box	Stiffness
MPL2-0625H	6 F / 20 cm	5	Origin
MPL2-0830H	8 F / 25 cm	5	Origin
MPL2-1030H	10 F / 25 cm	5	Origin
Product Code	Size/Length	Units/Box	Stiffness
MPL2-0830HB	8 F / 25 cm	5	Regular
MPL2-1030HB	10 F / 25 cm	5	Regular



Short Mini-Pigtail® Drainage Catheter with locking pigtail

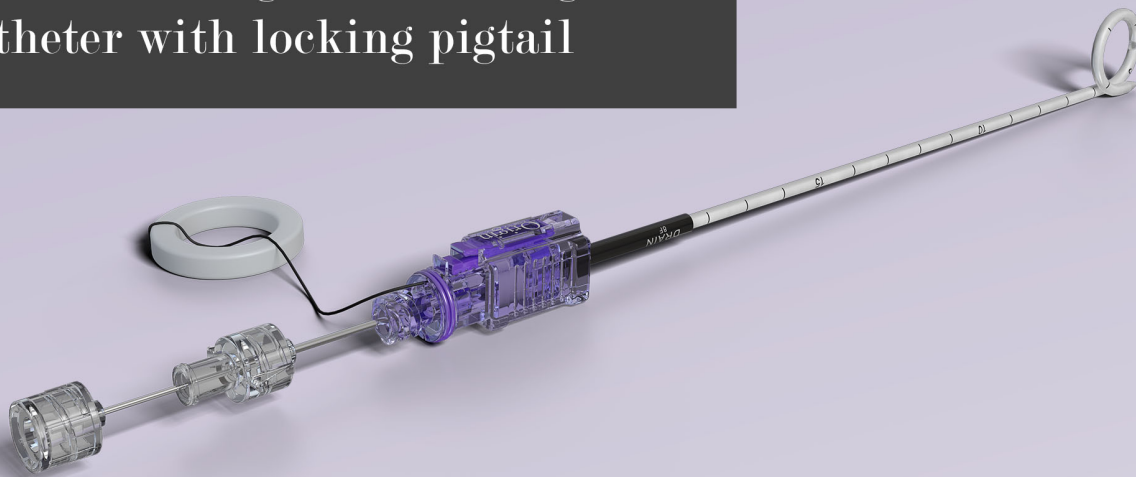

- UreSil's Short MiniPig Catheter (KDL) has an overall length of only 17cm.
- This catheter was developed to assist with the drainage of abscesses closer to the surface or in patients with smaller anatomy.
- Every KDL Catheter includes the following; Catheter, Metal Cannula, Trocar and Hydrophilic Coating.
- Short MiniPig Catheters are available in 8F through 10F diameters in both durometers. 6F available in the Origin® material.

Product Code	Size/Length	Units/Box	Stiffness
KDL2-0617H	6 F / 12 cm	5	Origin
KDL2-0817H	8 F / 12 cm	5	Origin
KDL2-1017H	10 F / 12 cm	5	Origin
Product Code	Size/Length	Units/Box	Stiffness
KDL2-0817HB	8 F / 12 cm	5	Regular
KDL2-1017HB	10 F / 12 cm	5	Regular



General-Purpose Drainage Catheter with “J” tip

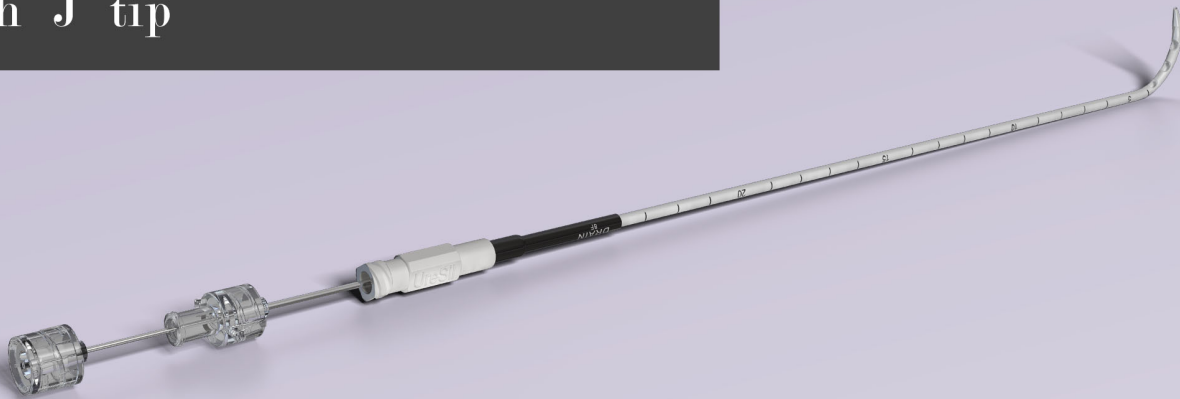

- UreSil’s Non-Locking General Purpose Catheter (GPJ) offers all of the features of our General Purpose Catheters but in a non-locking format.
- Every GPJ Catheter includes the following; Catheter, Metal Cannula, Trocar and Hydrophilic Coating.
- GPJ Catheters are available in 8F through 12F in both durometers. A 6F is available in our Origin® material and 14F is available in our regular material.

Product Code	Size/Length	Units/Box	Stiffness
GPJ-0620H	6 F / 15 cm	5	Origin
GPJ-0825H	8 F / 19 cm	5	Origin
GPJ-1025H	10 F / 19 cm	5	Origin
GPJ-1225H	12 F / 19 cm	5	Origin

Product Code	Size/Length	Units/Box	Stiffness
GPJ-0825HB	8 F / 19 cm	5	Regular
GPJ-1025HB	10 F / 19 cm	5	Regular
GPJ-1225HB	12 F / 19 cm	5	Regular
GPJ-1425HB	14 F / 20 cm	5	Regular



ULTI-flo® TRU-SET large I.D. - with aspiration flush (A-F) Adapter/pigtail

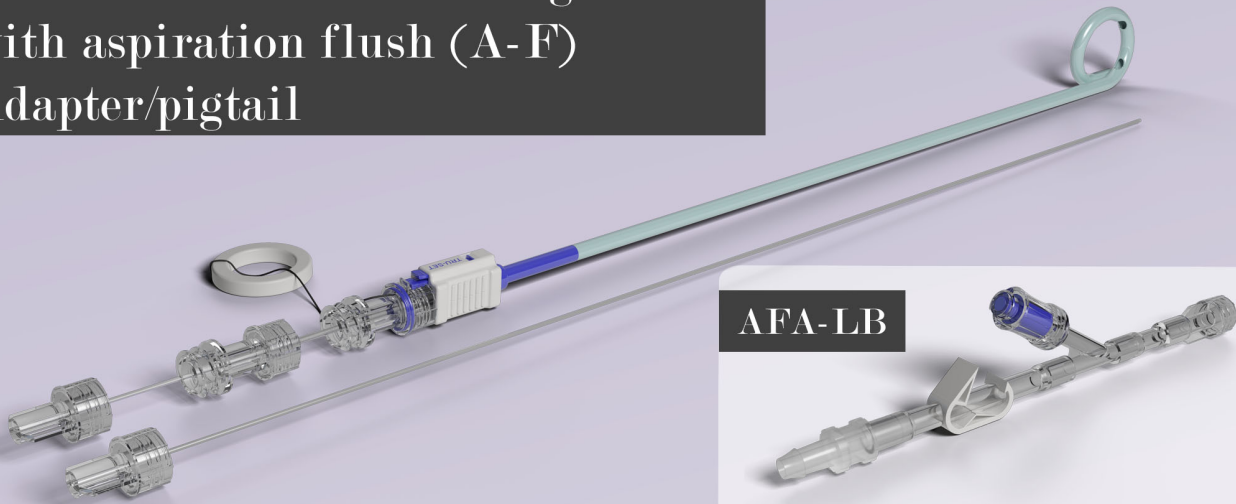

- UreSil's Ulti-flo Locking Catheter (LBL) was designed to solve a common problem with flow dynamics in abscess drainage.
- The internal diameter of a standard luer connection is roughly equivalent to the internal diameter of a 12F catheter. When a 14F or 16F catheter with standard luer lock is employed, the inner lumen of the luer lock creates a choke point for drainage.
- The LBL utilizes a patented hub that maintains 14 or 16F drainage from the catheter all the way to the the drainage bag. This maximized lumen minimizes the potential for blockages.
- Every LBL kit comes with the following: Catheter, Metal Cannula, Trocar, Flexible Cannula, Large Bore Aspiration / Flush Adapter and Large Bore Syringe Adapter.
- UreSil's Ulti-flo catheters are available in 14F and 16F diameters.

Product Code	Size/Length	Units/Box	Stiffness
LBL2-1430HB	14 F / 19 cm	5	Regular
LBL2-1630HB	16 F / 20 cm	5	Regular



ULTI-flo® 20+ General Purpose Catheter (non-locking)

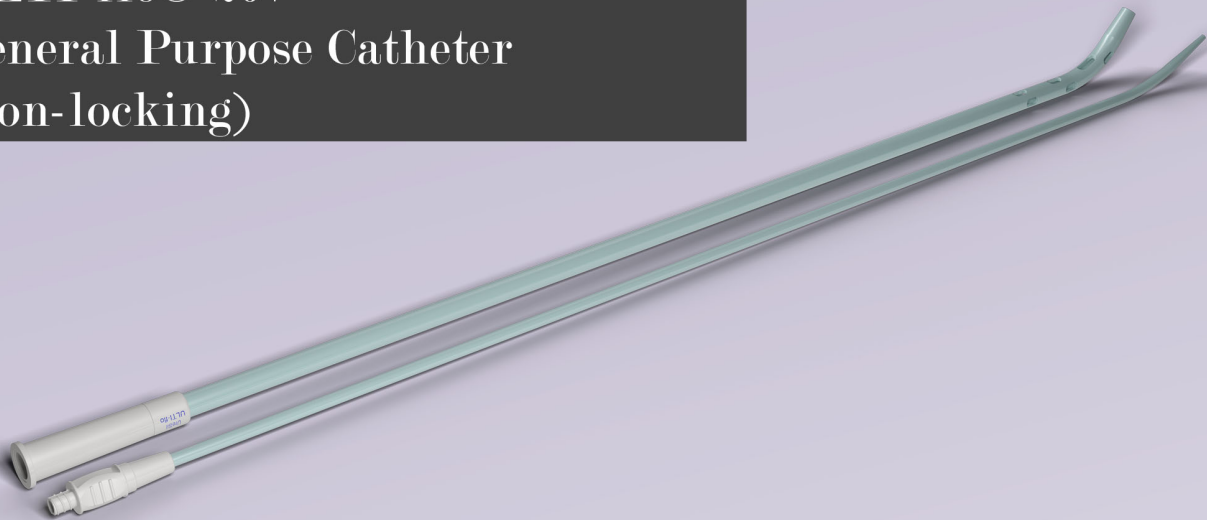

- UreSil's 20+ Non-Locking Catheter (LBNL) was born from the necessity to provide 20F, 24F and 28F catheters for interventional drainage. Ulti-flo catheters possess a radiopaque stripe to increase visualization during introduction and are made of a softer material that provides flexibility and comfort while dealing with large abscesses or other fluids such as pancreatic pseudocysts.
- Every set includes the following: Catheter and Introducer that accommodates either .035" or .038" guidewire.

Product Code	Size/Length	Units/Box	Stiffness
LBNL-2050H	20 F / 41 cm	5	Firm
LBNL-2450H	24 F / 41 cm	5	Firm
LBNL-2850H	28 F / 41 cm	5	Firm



NEPHRO-CATH™ Nephrostomy Drainage Catheter with locking pigtail

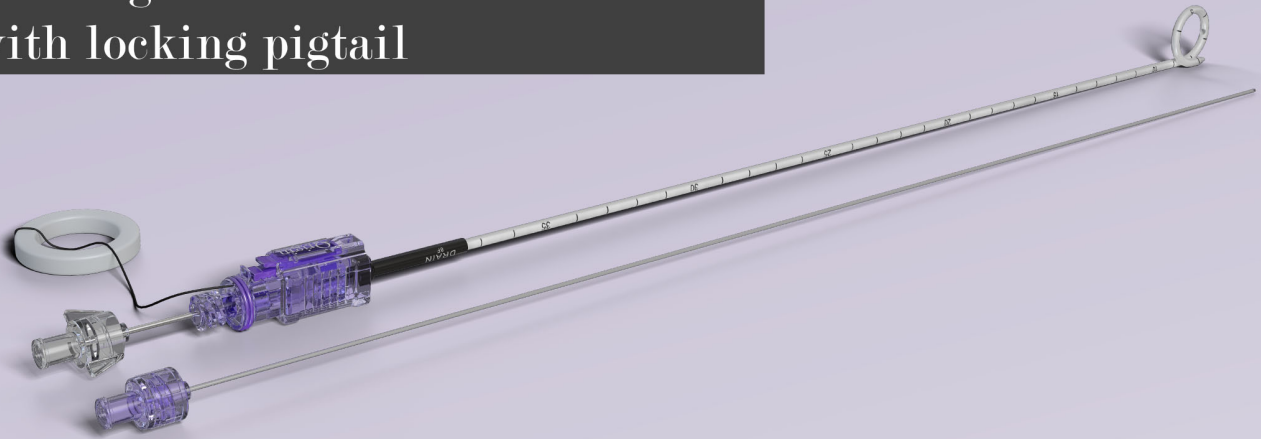

- UreSil's Nephrostomy Catheter (NCL) includes all of the features found in the General Purpose Catheters except for a trocar, and is approximately 5 cm longer to allow for placement within the kidney for drainage.
- These catheters are available in two different durometers based upon patient population and need.
- UreSil has also introduced a longer 50 cm version of this catheter in the regular material to accommodate larger patients where increased length is necessary.
- Every NCL catheter is available in 8F – 14F diameters and includes the following: Catheter, Metal Cannula, Flexible Cannula and Septum Cap.

Product Code	Size/Length	Units/Box	Stiffness
NCL2-0835HB	8 F / 28 cm	5	Regular
NCL2-1035HB	10 F / 28 cm	5	Regular
NCL2-1235HB	12 F / 27 cm	5	Regular
NCL2-1435HB	14 F / 28 cm	5	Regular
Product Code	Size/Length	Units/Box	Stiffness
NCL2-0835H	8 F / 28 cm	5	Origin
NCL2-1035H	10 F / 28 cm	5	Origin
NCL2-1235H	12 F / 27 cm	5	Origin
NCL2-1435H	14 F / 28 cm	5	Origin
Product Code	Size/Length	Units/Box	Stiffness
NCL2-0850HB	8 F / 41 cm	5	Regular
NCL2-1050HB	10 F / 41cm	5	Regular
NCL2-1250HB	12 F / 40 cm	5	Regular
NCL2-1450HB	14 F / 40 cm	5	Regular



CHOLE-CATH® Biliary Drainage Catheter with locking pigtail

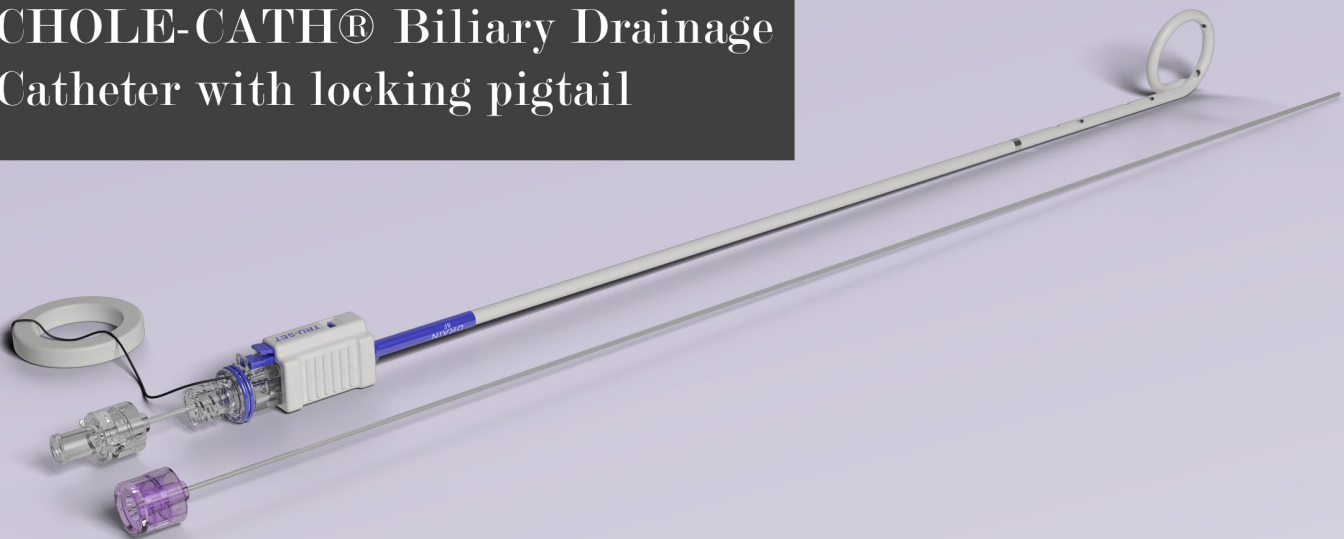

- UreSil offers a wide array of Biliary Catheters (CCL).
- All Biliary Catheters come with a radiopaque (RO) marker located adjacent to the proximal hole to facilitate proper placement under imaging guidance.
- All regular Biliary Catheters are available in 8F to 16F diameters.
- All stiff Biliary Catheters are available in 8F-14F diameters.
- All extended hole Biliary Catheters are available in 8F-12F diameters, and are designated by the addition of an "X" suffix.
- Every Biliary Catheter includes the following: Catheter, Metal Cannula, Flexible Cannula, Septum Cap and RO Marker.

Product Code	Size/Length	Units/Box	Stiffness
CCL2-0850HB	8 F / 41 cm	5	Regular
CCL2-1050HB	10 F / 41 cm	5	Regular
CCL2-1250HB	12 F / 40 cm	5	Regular
CCL2-1450HB	14 F / 40 cm	5	Regular
CCL2-1650HB	16 F / 40 cm	5	Regular
Product Code	Size/Length	Units/Box	Stiffness
CCL2-0850H	8 F / 41 cm	5	Firm
CCL2-1050H	10 F / 41 cm	5	Firm
CCL2-1250H	12 F / 40 cm	5	Firm
CCL2-1450H	14 F / 40 cm	5	Firm
Product Code	Size/Length	Units/Box	Stiffness
CCL2-0850HBX	8 F / 41 cm	5	Regular
CCL2-1050HBX	10 F / 41cm	5	Regular
CCL2-1250HBX	12 F / 40 cm	5	Regular



CHOLE-CATH® Biliary Drainage Catheter with locking pigtail

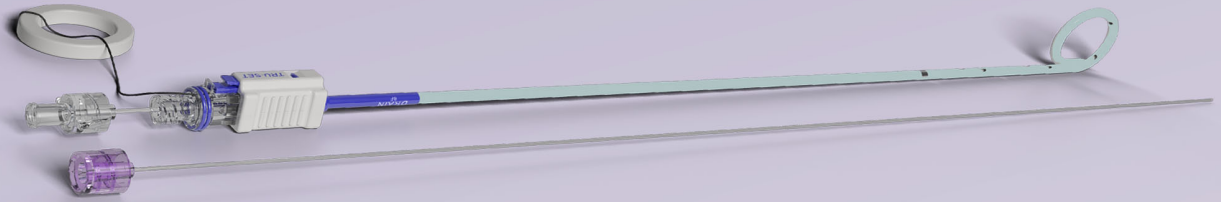

NEPHRO-CATH™ Nephrostomy Drainage Catheter with locking pigtail

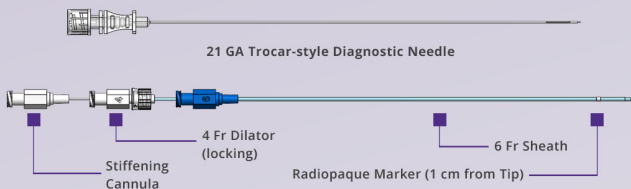
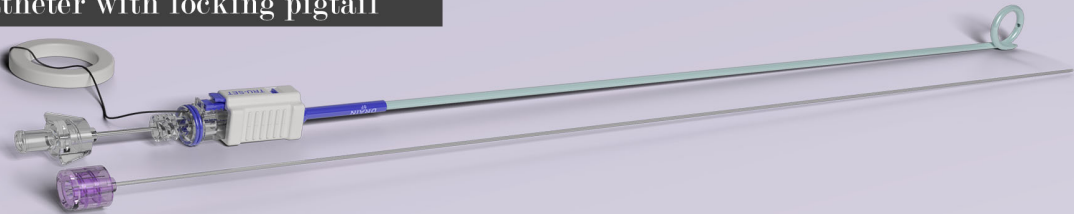

"POSI-STICK®" Introducer Set:
Coaxial 4 Fr Dilator & 6 Fr Sheath with Radiopaque Marker and Stiffening Cannula

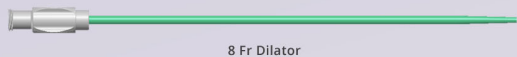

8 Fr Dilator



10 Fr Dilator



12 Fr Dilator (10 Fr Kits only)



0.018" (.46 mm) Guidewire with Floppy Radiopaque tip 70 cm Wire Length



0.038" (.96 mm) Guidewire with Floppy Tip & "J" Tip 150 cm Wire Length

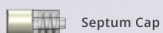

Septum Cap



Flexible Cannula

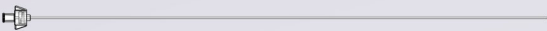

Metal Flexible Cannula



Drainage Catheter

CHOLE-CATH Biliary Drainage Catheter Kit with RO Marker

Product Code	Size/Length	Units/Box
CCL2-0850HB-K	8 F / 41 cm	5
CCL2-1050HB-K	10 F / 41 cm	5

NEPHRO-CATH Nephrostomy Drainage Catheter Kit

Product Code	Size/Length	Units/Box
NCL2-0835HB-K	8 F / 28 cm	5
NCL2-1035HB-K	10 F / 28 cm	5

UreSil's Biliary Kits include items needed to perform a biliary procedure.

UreSil's Nephrostomy Kits include items needed to perform a nephrostomy procedure.

The kits are available in 8F through 10F diameters and include the following:

- Catheter
- Metal Cannula
- Flexible Cannula
- Septum Cap
- Posi-Stick® Introducer Set with Radiopaque Tip (Coaxial 4F/6F dilator set with cannula)
- 21 GA needle with Echogenic Tip
- .018", 70cm long Nitinol Guidewire with Floppy Radiopaque Tip
- .038", 150cm long Guidewire
- 8F and 10F Dilators (10F kits also contain 12F Dilator)



NEPHRO-STENT™ Nephroureteral Stent Catheter with locking pigtail



- In 2015, UreSil introduced the Nephroureteral Stent Catheter (NU) to its product portfolio.
- This product was developed in conjunction with numerous IR Physicians and is intended to address the shortcomings of other NU stents on the market.
- Its key features include an increase in the number of drain holes, a highly visible radiopaque (RO) marker, a smaller bladder pigtail, a rigid cannula and a flexible cannula with obturator to facilitate placement.
- Every NU Stent Catheter includes the following; Catheter with RO Marker, Metal Cannula, full length Flexible Cannula with Obturator, Septum Cap and Hydrophilic Coating.

Product Code	Size/Length	Units/Box	Stiffness
NSL2-0822H	8 F / 66 cm	5	Firm
NSL2-0824H	8 F / 68 cm	5	Firm
NSL2-0826H	8 F / 70 cm	5	Firm
NSL2-0828H	8 F / 72 cm	5	Firm
NSL2-1022H	10 F / 66 cm	5	Firm
NSL2-1024H	10 F / 68 cm	5	Firm
NSL2-1026H	10 F / 70 cm	5	Firm
NSL2-1028H	10 F / 72 cm	5	Firm



THORA VENT®

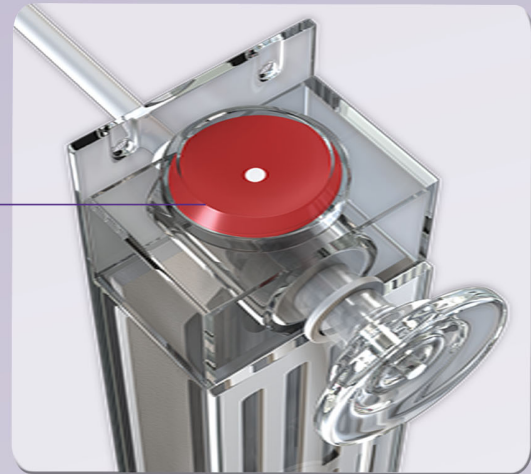
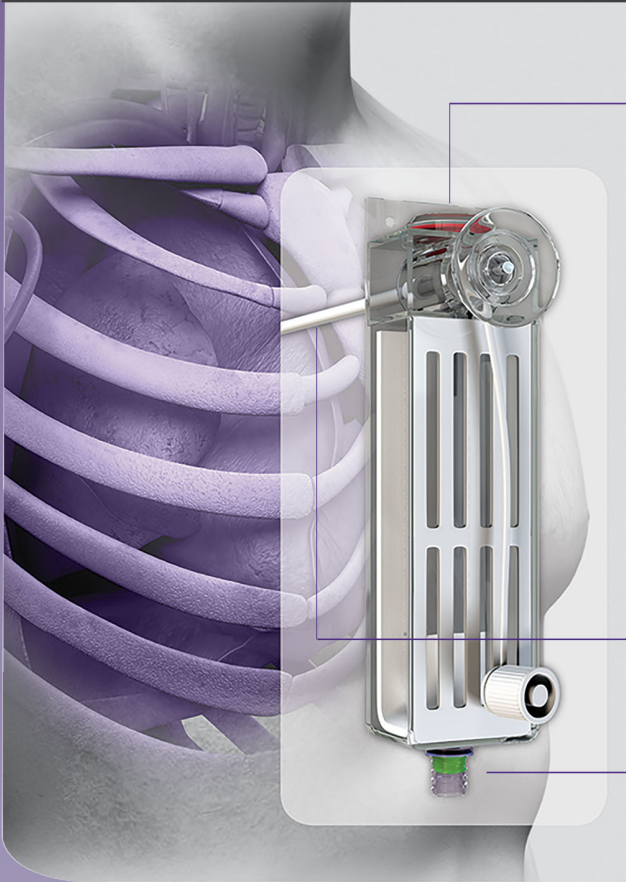

Red Signal Diaphragm

Fluctuations demonstrate entry of the catheter into the pleural cavity with pressures greater than 2mm Hg and less than - 2mm Hg

Continues to fluctuate with respiration until the pneumothorax is resolved as confirmed by x-ray

Flexible Catheter

Immediately vents air through the one way valve

Syringe-Activated Drain Port

Facilitates aspiration of small amounts of fluid

- UreSil's flagship product, the Thora-Vent has become one of the most commonly accepted choices for physicians treating simple pneumothorax throughout the world.
- Thora-Vent is unique in that it allows for active monitoring of the patient's pneumothorax during treatment and provides for maximum ambulation as well.
- Available in multiple sizes, Thora-Vent is an excellent option for the resolution of simple pneumothorax.
- Available with an over the wire insertion option.
- Every kit includes the following: Thora-Vent with Trocar, Aspiration Cannula, Suction Tubing Set, 60cc Syringe, Halstead Forceps, Vent Occlusion Plug, Gauze Sponges, Protected Disposable Scalpel, CSR Wrap and Fenestrated Drape.

THORA-VENT Procedure Tray

Product Code	Size/Length	Units/Box
TV11-10	11 F / 10 cm	1
TV11-13	11 F / 13 cm	1
TV13-10	13 F / 10 cm	1
TV13-13	13 F / 13 cm	1

THORA-VENT Accessories

Product Code	Description	Units/Box
TVST	Thora-Vent Suction Tubing	5
TVOCP	Vent Occlusion Plug	5
OTW11-13	Over-the wire Insertion Cannula for TV11-13	5



Evolution®

Evacuated Suction Bottles

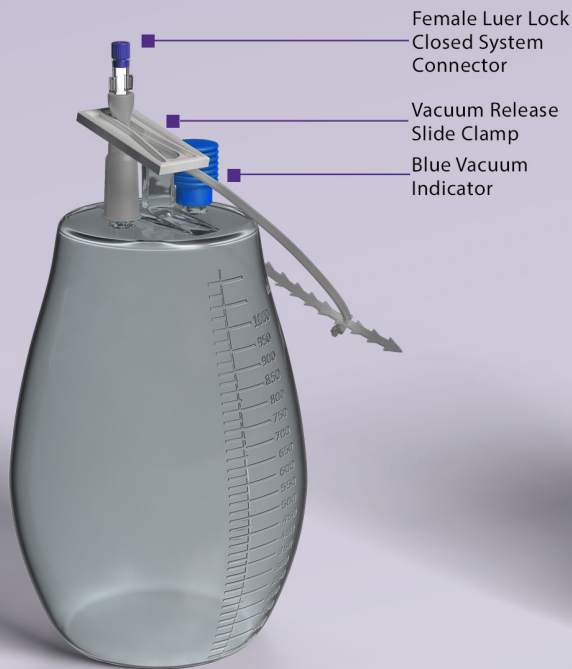

ESB-1000SP Non-Sterile

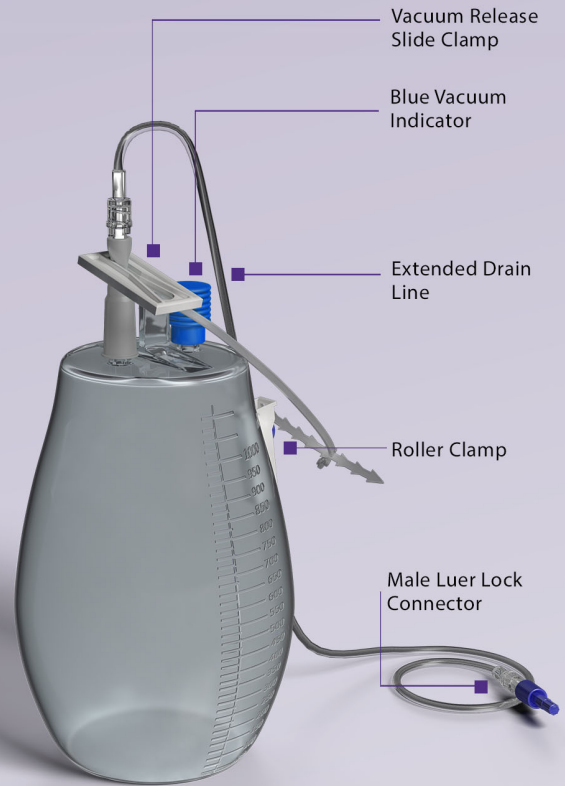

ESB-1000FS-T Sterile Drain Line

- The Evolution line of evacuated suction bottles is widely used for paracentesis, thoracentesis and other drainage procedures.
- The Evolution Bottle is not made from glass and is reliably available for purchase.
- The luer lock design allows for Evolution to be used with most catheters available on the market.
- Evolution is widely gaining acceptance as a reliable, cost effective, latex-free alternative to most options on the market.
- These bottles are available in a non-sterile format with sterile tubing sold separately or packed in a sterile pouch with tubing already connected.

Product Code	Description	Units/Box
ESB-1000SP	1000 ml Evacuated Bottle w/Luer Connection Only, Non-Sterile	12
ESB-1000FS-T	1000 ml Evacuated Bottle w/Sterile Drain Line	10
ESB-ST	Sterile Tubing Only	10



Not available where CE mark is required for sale.

TCS500DS

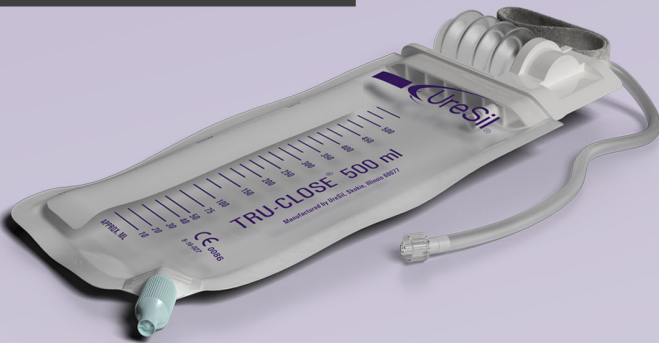

- UreSil's most widely recognized product is the TRU-CLOSE® TCS Suction Drainage Bag.
- This product will attach to any luer locking drainage catheter and can remove fluids using active suction or gravity.
- Available in a variety of sizes and configurations, every TRU-CLOSE® bag has two anti-reflux valves, provides active suction and is simple and intuitive to operate.
- TCS Bags are available in 300ml, 500ml and 1,000ml configurations and can come with or without a drain port in all sizes except for the 1,000ml version.

Product Code	Description	Units/Box
TCS500	500 ml w/o Drainage Port	10
TCS1000	1000 ml w/o Drainage Port	10
TCS500D	500 ml with Drainage Port	10
TCS300D	300 ml with Drainage Port	10
TCS500DS	500 ml with Drainage Port	10

TCS1000

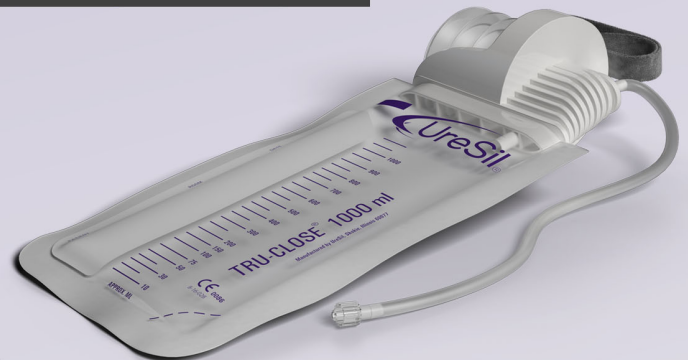

TCS300D

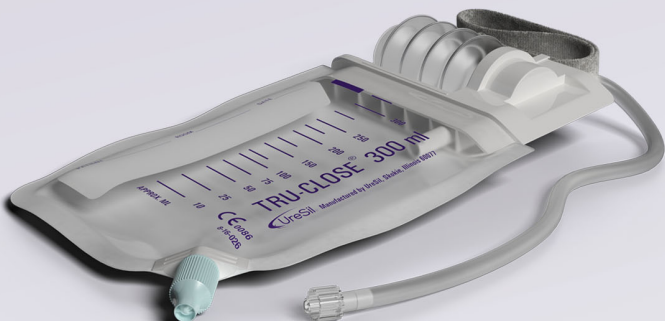

Optimus™



- UreSil's Gravity Drainage Bags are made from a high quality plastic film, provide reliable collection, and have become one of the most widely purchased gravity bag products for interventional drainage.
- The TC600 comes with a 600ml drainable collection bag, 20" of stretchable tubing, a luer lock connector, a loop belt and an elastic hook.
- The TC600L is identical, but comes equipped with 36" of stretchable tubing with a luer lock connector.

Product Code	Description	Units/Box
TC600	Gravity Drainage System with 600 ml drainable collection bag, elastic hook-and-loop belt and 20" stretchable tubing with luer lock connector	20
TC600L	Gravity Drainage System with 600 ml drainable collection bag, elastic hook-and-loop belt and 36" stretchable tubing with luer lock connector	20



AFA-LL

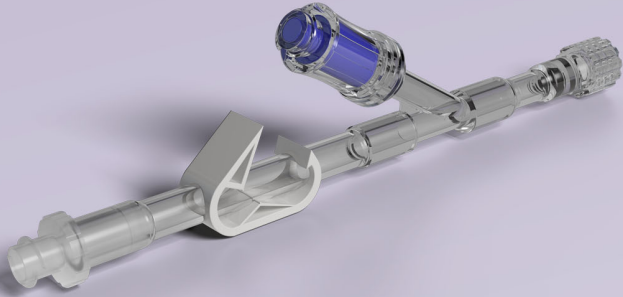

- The Aspiration Flush Adapter with Luer Lock Connections was developed based upon multiple clinical requests.
- In essence, this product replaces the flow limiting three way stop-cock with something reliable, intuitive and easy to use for patients, physicians and nurses the world over.
- The AFA-LL can be used with any bag and any catheter commonly found in practice today.

Product Code	Units/Box
AFA-LL	5

- The 20F Plus Aspiration Flush Adapter offers the ability to flush and aspirate any funneled large bore catheter while maintaining a closed system.
- This product was developed based upon a large amount of feedback from clinicians who utilize 20F or higher diameter catheters.

AFA-20P

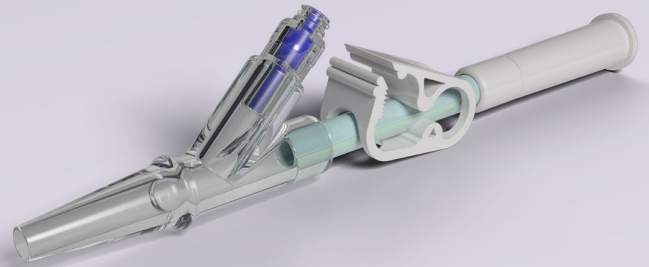

Product Code	Units/Box
AFA-20P	5

AFA-LB

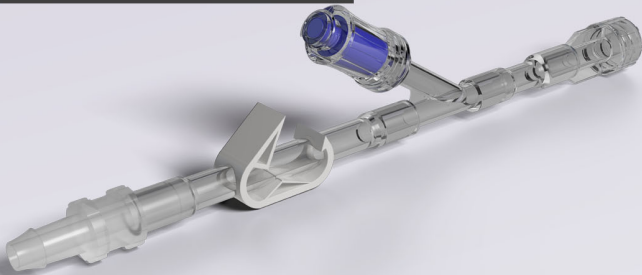

- The AFA-LB is a duplicate of the device provided in our LBL Catheter Kits.
- The AFA-LB allows connection of the UreSil LBL catheter to any standard drainage bag.

Product Code	Units/Box
AFA-LB	5



DFA-LL

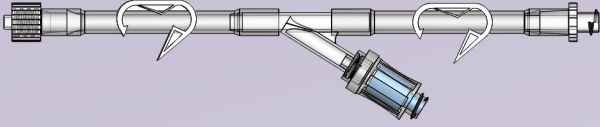

- Similar to the AFA-LL but includes an additional clamp that can be used to allow flushing towards the catheter or the bag.

Product Code

Units/Box

DFA-LL

5

- This device was created to provide a way to adapt funnel connections to luer connections.

UFA-LL

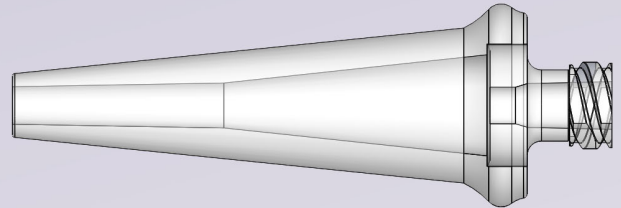

Product Code

Units/Box

UFA-LL

5



PDC-36

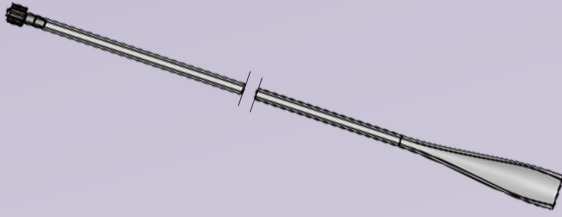

- The PDC is a 36" long length of tubing that offers a method for connecting a basic urinary drain bag or water seal device to any standard drainage catheter by utilizing a luer connection.

Product Code	Units/Box
PDC-36	10

- The TCY2 tubing is used to offer bilateral drainage to a single bag.

TCY2



Product Code	Units/Box
TCY2	5



Fortitude™

Universal Catheter Fixation Device

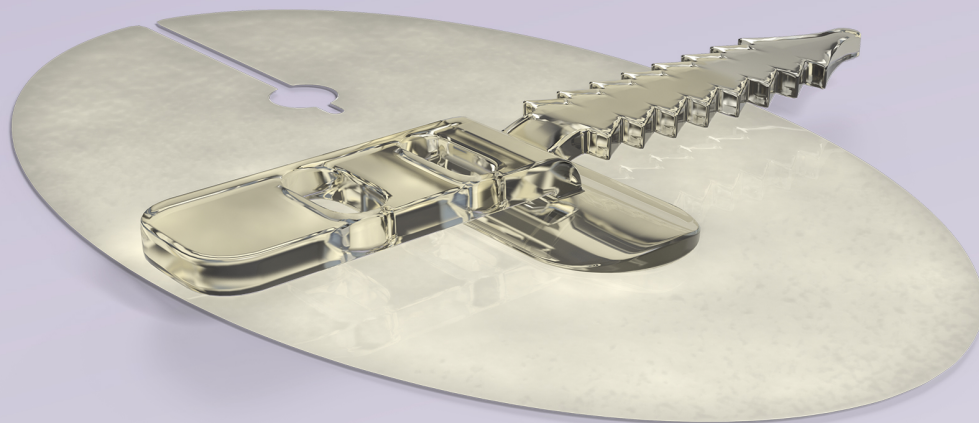

Fortitude is a device that was developed to address the consistent clinician requests for a universal fixation device that would stand up to the day to day activities of patients on an inpatient or outpatient basis. The call was to also have an adhesive that is hypoallergenic and rugged as to adhere well to a variety of skin conditions without causing irritation or further complications. Fortitude addresses these concerns and also does not contain any rigid plastic parts that can cause further patient discomfort while providing incredible securement of any common catheter.

- Hydrocolloid adhesive material for secure, hypoallergenic adhesion to patient skin.
- Dressing can be used in an occlusive and non-occlusive manner.
- Soft, secure strap to assist in reducing patient discomfort.
- Truly universal fit that accommodates 2F - 32F sizes.

Product Code	Description	Units/Box
SG-0232	Universal Catheter Fixation Device Accommodating 2F - 32F Sizes	30

Not available where CE mark is required for sale.



TRU-FIX™ Fixation Devices

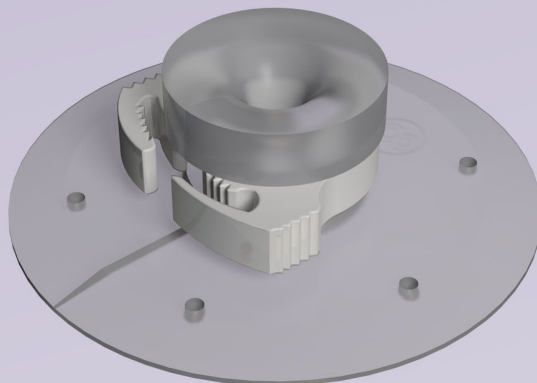

- Developed in conjunction with one of the busiest cancer institutes in America, the TRU-FIX Catheter Fixation Device provides for reliable and consistent catheter fixation.
- Available in multiple sizes to suit your needs, this product includes: Fixation Disk with Securing Clamp and Adhesive Dressing.

Product Code	French Size	Units/Box
TFK-06	6 F	5
TFK-08	8 F	5
TFK-10	10 F	5
TFK-12	12 F	5
TFK-14	14 F	5
TFK-16	16 F	5



POSI-STICK® Introducer Sets

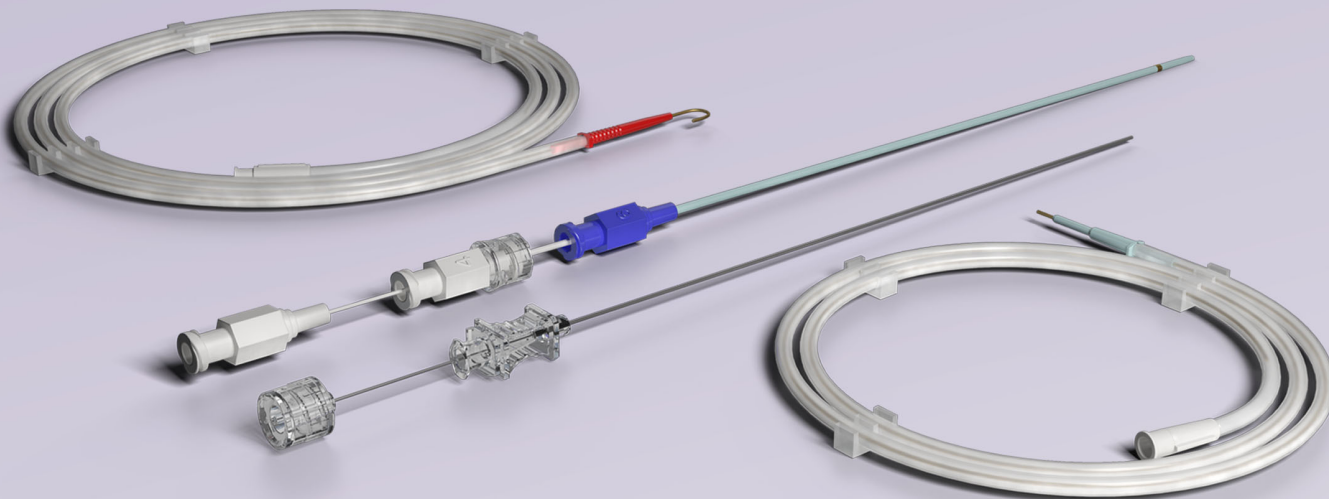

One Step™ Introducer Set

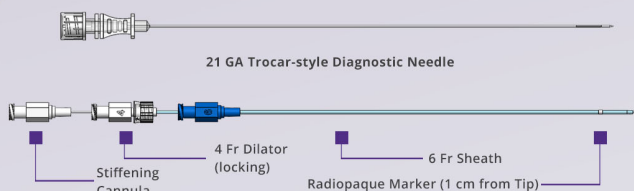

"POSI-STICK®" Introducer Set:
Coaxial 4 Fr Dilator & 6 Fr Sheath with Radiopaque Marker and Stiffening Cannula

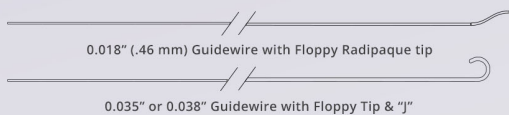

Product Code	"POSI-STICK®" Introducer Set	Nitinol Guidewire (0.18" 70 cm length)	Guidewire (0.38" 150 cm length)	Guidewire (0.35" 150 cm length)	Dilator (5 Fr) with locking trocar	Guidewire (0.38" 100 cm length)	Units per Box
PS2-38	✓	✓	✓	✓			10
PS2-35	✓	✓	✓		✓		10
PS2-18*			✓				5
PS2-00	✓	✓	✓				10
PS2-15						✓	5

* Replacement 0.018" (.46 mm) Guidewire for PS2-35 & PS2-38

"POSI-STICK®" Set Configurations



Products manufactured in U.S.A. by:



UreSil, LLC, 5418 W. Touhy Ave.,
Skokie, IL 60077
Tel: (800) 538-7374 Tel: (847) 982-0200
Fax: (847) 982-0106

THORA-VENT, Ureflex, Mini-Pigtail, UreSil, CHOLE-CATH,
TRU-CLOSE, TRU-SET, ULTI-flo, Evolution, Origin, and
POSI-STICK are registered trademarks of UreSil, LLC.
GP, NEPHRO-CATH, NEPHRO-STENT, Optimus, Fortitude,
TRU-FIX, and One Step are trademarks of UreSil, LLC.
Products covered by one or more of the following U.S. patents:
6,770,063; 8,177,773; 9,079,006B1; DES. 585,134S
Doc. no. MK-UPC Rev 1/2/19 ©2018 UreSil, LLC

Terms are Net 30 Days. All shipments are F.O.B. Skokie, Illinois.
Prices are subject to change without notice.

RETURNED GOODS:

Approval to return merchandise is required for all returns.
Contact UreSil Customer Services for a Return Goods Authorization
Number at 800-537-7374. The request for returns should include
the reason, catalog number, lot number and UreSil Invoice number.
All items must be returned unopened, in full boxes only and are
subject to a 20% restocking charge. Returns will only be accepted
within ninety days of date of invoice. Material that has been
opened, damaged or tampered with is not returnable for credit.
Products manufactured as CUSTOM products are not returnable
for credit.

UreSil.com